

PWHY Digital Crane Scales

User's Manual / Manual de usuario
Safety Warnings / Advertencias de Seguridad

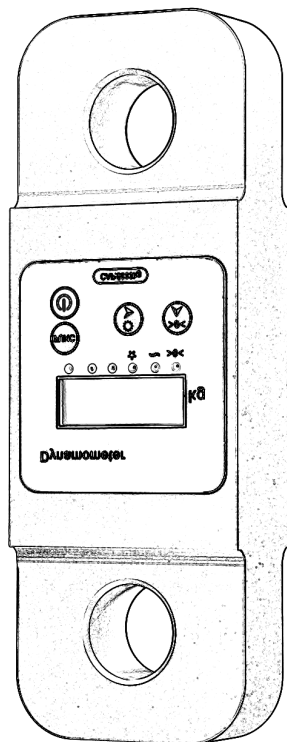



PWHY5T



PWHY10T



PWHY25T



PWHY50T



PWHY100T



PWHYCS1T



PWHYCS5T



PWHYCS10T



PWHYCS20T



PWHYCS30T



PWHYCS50T



PWHY280



PWHY680



PWHY18

PROPERTY REGISTRY N° 189487
ANY REPRODUCTION IS FORBIDDEN
PROPERTY OF PROWINCH® 2018 - V8.0 ALL RIGHTS RESERVED
PROWINCH LLC COMPANY WITH QUALITY MANAGEMENT SYSTEM

PROWINCH® DISCLAIMER

Prowinch® LLC declares that it has made available to the Customer each and every one of the security warnings related to the purchased product and that, as a result, it does not assume any responsibility for any damages or losses that may be suffered by the client or third parties, cause or as a direct or indirect consequence of the breach or omission of any of the instructions or safety warnings contained in the User Manual and Security Warnings corresponding to the unit purchased.

In this sense, Prowinch® LLC will not be liable for accidents and / or damages to persons and / or property resulting from the negligent use of the product. In no case does Prowinch® LLC assume any liability arising from the use of these voluntary recommendations, and does not offer any guarantee in relation to them. These recommendations do not take precedence over the current safety regulations of the plant. For purposes of enforcing the Warranty of the product purchased, Prowinch® LLC, will only be liable for any damage when it is possible to prove that the user has followed each and every one of the warnings contained in the User Manual and Safety Warnings.

1. It is the sole responsibility of the Client / User to verify that the acquired equipment, products and accessories comply with the characteristics, capacities, requirements, components, accessories and other conditions for the use that the Client / user intends to give it.

2. It is also the sole responsibility of the Client / User to ensure that the equipment and products purchased are operated and maintained with adequate safety standards and by personnel duly trained in the use thereof. The Client / User is also responsible for implementing all the security measures necessary to prevent accidents or damages to people or property and for following the indications and warnings of the corresponding manual.

3. Any assistance provided by Prowinch® LLC in the selection of the equipment, the capacities and characteristics required by the clients is delivered free of charge and based on the information about the application, use and requirements indicated by the Client itself. It does not correspond to Prowinch® LLC to verify the accuracy of the given information. It is the sole and exclusive responsibility of the Client -or who will use the equipment and products acquired- to ensure that the specifications comply with the capabilities, characteristics, up-to-date maintenance and everything necessary for a correct and safe operation in relation to the intended use.

4. Prowinch® LLC recommends the use of winches with 4 brakes for personnel lifting. The use of winches of 3 brakes or less or safety features lower than the best available for personnel lifting, is the sole responsibility of the customer in order to guarantee the safety of the personnel and users of the equipment it is necessary to carry out the inspections

and maintenance of the equipment according to the recommended frequency in relation to its work cycle. It is mandatory to keep record and evidence the written and photographic reports of: Maintenance, Start-up, Load Tests, Training, Certifications, Inspections and Reports of failures and accidents.

5. The aforementioned reports must be sent by email to registros@prowinch.com within the first 7 calendar days after the occurrence of an event.

6. Compliance with the timely implementation of the mandatory activities described in points 6 and 7 in addition to all the activities mentioned in the corresponding rules applied are the sole responsibility of the user. Failure to comply with the foregoing conditions releases Prowinch® LLC from any type of Liability and Warranty to the team, customer, staff or user, or any other liability that could be attributed to Prowinch® LLC.

7. The information contained in this manual may contain technical errors or inaccuracies. Prowinch® LLC is not responsible for typing errors, omission or incorrect information.

8. This manual is subject to change without prior notice. Download the latest version available at www.prowinch.com.

9. Always check www.prowinch.com for the latest information regarding this product.

Thank you for purchasing a Prowinch® PWHY Wireless Control. This manual describes the operation and maintenance of the control. All information in this publication is based on the newest production information is available at print time.

1. SAFETY PRECAUTIONS

The PWHY Prowinch® dynamometer is designed and made of highly resistant materials, according to the standards for measuring equipment. Designed to accurately and precisely measure loads of different dimensions. Through your shipping module allows the transmission of data in real time that can be read and recorded by means of a receiver wireless (PWHY280). We recommend always use Prowinch® parts and accessories.

Applications for PWHY dynamometer

- They are suitable for use in the mining, oil, petrochemical, construction, among others.
- The PWHY series of dynamometers offers features and notable benefits:
- Compact and light structure, body made with high strength alloys.
- Designed to offer a degree of protection IP68 allowing you to work in environments with high dust and moisture concentrations.
- High reliability in measurements.
- Adaptable to a variety of wireless receivers Prowinch®.

Mandatory use of:



Hard Hat



Safety Glasses



Safety Gloves



Safety Shoes

1.1. Safety Precautions

**WARNING:**

This symbol indicates unsafe practices or situations which may cause damage to the property and even injuries to the personnel.

**DANGER:**

This symbol indicates a potentially dangerous situation which if not avoided may cause severe injuries or death

Read and understand the contents of this User Manual thoroughly before handling the product.

Practicing correct and safe operating procedures and carrying out the recommended preventative maintenance will ensure a long, reliable, and safe service.

After carefully reading and understanding the User Manual, store it for future reference.

GENERAL PRECAUTIONS

Due to the environmental conditions to which this equipment is generally exposed, it is essential to comply with a series of instructions and recommendations that ensure proper operation and mitigate any Possibility of equipment failure and / or injury or death.

- The PWHY Prowinch® dynamometer must be installed, inspected, configured, operated by a professional trained, certified and authorized by the equipment owner.
- Verify that the chosen PWHY series dynamometer is suitable for the type of load you wish to measure and that the operating conditions are within the operating range of the equipment.
- Before putting the PWHY dynamometer into service, it is recommended to verify that the batteries are in good condition. state and with sufficient charge.
- When lifting loads it is necessary to follow the safety recommendations.
- Do not use pulleys or accessories that are not approved for this equipment.
- Make sure this equipment works properly without load, before charging.
- Be sure to remove the batteries when they are not going to be used for long periods.
- Do not wear loose clothing or jewelry
- We recommend using safety equipment when lifting loads: Helmet, gloves, goggles and safe boots
- Do not get under load or allow others to do so.
- Before use, it is necessary to check the equipment completely. It is necessary that an authorized service center Prowinch repair or replace any part that is damaged.



DANGER:

Failure to observe these instructions could lead to serious injury or death.

HANDLING PRECAUTIONS

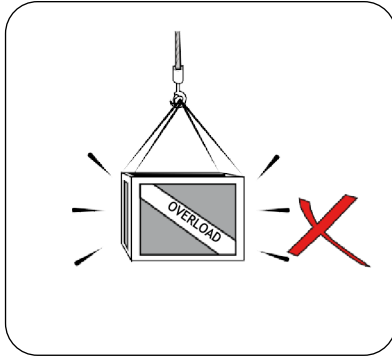

1. Do not overload the dynamometer. Check the load capacity before use the equipment. Check the electrical connections. Voltage may vary if not properly connected to power supply.

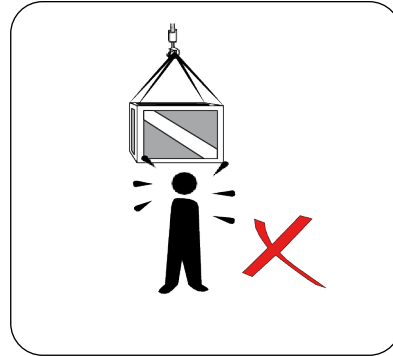

2. Do not stand under the load or allow others to do so.

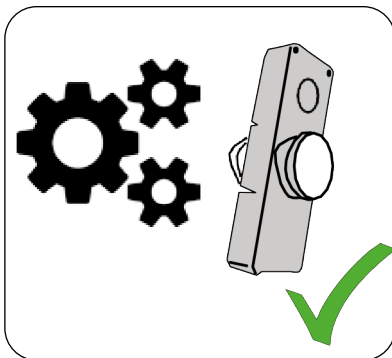

3. Regularly calibrate your equipment according to the indications described in this Handbook.

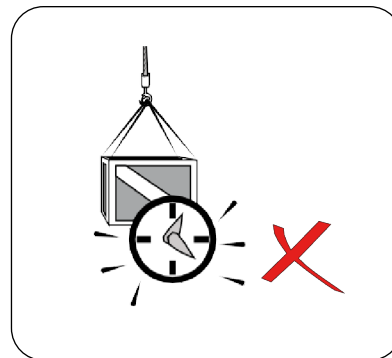

4. Do not hold loads for long periods as it may cause deformation of the equipment.

GENERAL ENVIROMENTAL PRECAUTIONS

Verify that your equipment model is suitable for the environmental conditions in which it will be used.

When used outdoors, a shelter is required to protect from harsh environmental conditions.

Temperatures below -10° C and above 40° C and / or Relative humidity of 85% can cause failure of the team.

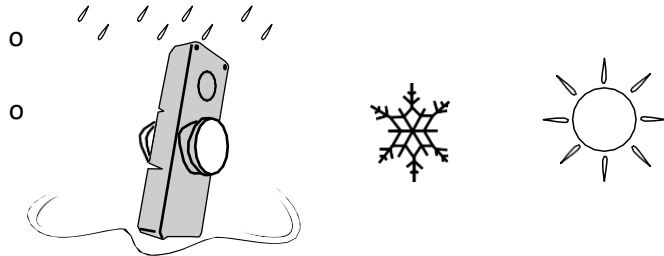

DANGER:

The following environmental conditions can cause malfunction of the equipment.

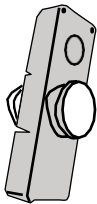

Avoid exposing to chemicals, corrosive gas, and / or explosives. Exposure to acid and / or salt can cause malfunctions.

WARNINGS



INTRODUCTION

The digital wireless weighing instrument of our factory adopts the high precision weight sensor and weighing instrument With the A / D switch, it features high reliability and good precision.

Caracteristics

- The waterproof, anti-collision and durable instrument case.
- Two-way wireless transmission of data.
- Moderate in size and easy to carry.
- •With the backlight that facilitates use at night.
- With built-in mini printer which can print weighing results.
- 200 weighing data can be saved with memory still extendable.
- Multiple units of calculation can be chosen.
- The speed, amplitude, and stability of digital filtering can be configured.
- Accurate and adjustable clock and calendar.
- Large capacity lithium battery.
- Turn on and off at once without external switch.
- Automatically shuts off when the instrument is idle for half an hour.
- Contacting the wireless transmitter, sensor, and instrument body form a wireless weighing system full.

Technical Parameters

1. Acquisition speed: 80 times per second
2. Acquisition terminal sensor range: 1.5 ~ 3mV / V
3. Division unit: 1/2/5/10/20/50/100 Optional
4. Accuracy standard: OIML
5. Power source: Rechargeable lithium battery, 7.4V / 5000mAH
6. Adapter: DC8.4V / 1000mA
7. Wireless frequency: 430MHZ ~ 470MHZ, multiple frequency points can be set with the antenna built-in
8. Weight sensor power source: DC 5V \pm 5%
9. Data communication terminal: Wireless transmission or USB2.0 / RS232 (Optional), Speed of transmission: 1200/2400/4800/9600 Optiona
10. Continuous working time of the instrument's charged battery: 50 hours
11. Instrument battery charged standby time: 100 hours
12. Wireless transmission distance: more than 300m without block
13. Working temperature: 0 ° to - 40 ° C

- 14.** (14) Storage temperature: $-25^{\circ} \sim 55^{\circ} \text{C}$
- 15.** (15) Humidity: $\leq 85\% \text{ RH}$
- 16.** (16) Size: 280 * 250 * 100mm (Instrument) 80 * 55 * 30mm (Acquisition terminal)



Interruptor

Power on: Press the red button and hold it until the interface and version number appear.

Shutdown: Press the red button and hold it until the system shuts down. You can also press the [Reset] button to force shutdown when system is not normal.

[] Turn the screen backlight on or off.

[] Save all information in weight status, such as weighed value, truck number, number of merchandise and time. It will print automatically if configured like this.

[Function] Enter the setting menu on the main interface.

Up / Down / Left / Right / Return / OK: 6 keys used in setting the functions.

[1 / Truck No]: Number or enter the truck number.

[2 / ABC]: Number or long press to input letters.

[3]: Number.

[4 / Goods]: Number or enter the name / number of the goods.

[5 / Acc]: Number or accumulation.

[6 / L.F]: Number or put paper in the printer.

[7 / Tare Set]: Number or set the tare.

[8 / Store Tare]: Number or store the tare.

[9 / Tare]: Number or chip,

[0 / Zero]: Number or zero point,

[Reprint]: Reprint,

[Search]: Search / Calculate.

Main Interface

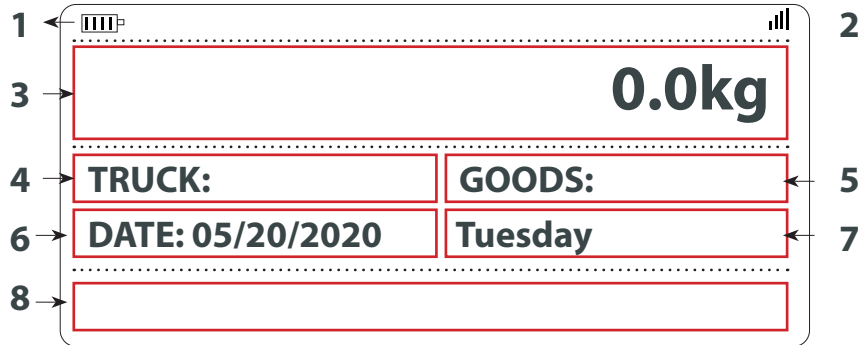

- (1) The remaining energy,
- (2) The strength of the wireless signal, appears "" when the signal is strong and "?" when no signal is detected.
- (3) The current weight appears when communication is normal and "-----" when the signal is not detected.
- (4) Truck number, press the [1 / Truck number] button to enter a number, press the [2 / ABC] button to enter other ASCII numbers.
- (5) Merchandise, used as above.
- (6) The system date appears.
- (7) The system week appears.
- (8) Message bar, information such as, "save", "chip", "set", "zero point", etc. appears.

Function Configuration

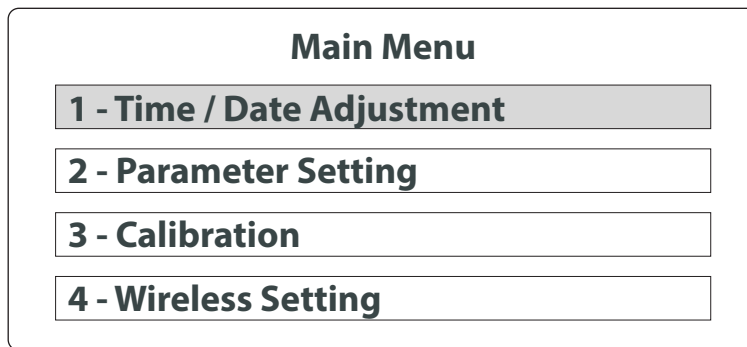

Press up/down to select a configuration and press [OK] to get in.

Time Configuration / Hour

Time / Date Adjustment

Data: / /

Time: : :

Press Up/ Down / Left / Right to choose the zone, type the numbers and press [OK] to save. The configuration time here is the time that is on the saving and printing data.

Parameters Configurations

Main Menu

| | |
|---------------------------|--------------------|
| 1 - Decimal Places | 2 - Unit |
| 2 - Dividing Value | 4 - Fiter |
| 3 - Zero Tracking | 6 - USB/COM |
| 7 - Others | |

Press Up/ Down / Left / Right to select a parameter and press [OK] to get in.

Decimal Configurations

Decimal Places Choose

Press Up/ Down to select the unit and weight then press [OK] to save.
Choose the point decimal place, depends the medication range and instrument precision.

Weight Unit

Unit Choose:

Press Up/ Down to select the unit and weight then press [OK] to save.
While the normal use if the unit change, the value will adjust automatically depends from the new unit.

Division Value

Dividing Value Choose

| | | |
|-----|-----|----|
| 1 | 2 | 5 |
| 10 | 20 | 50 |
| 100 | 200 | |

Press Up / Down / Left / Right to choose division unit and press "OK" to save it. Choose the appropriate dividing unit according to the practical use of the situation, scope and accuracy of the instrument, when the unit is small it will take longer to get a data and when the unit is large it will take less time to get data, but there is a greater margin for error.

Defilter Parameter

Filter Choose:

| | | |
|---|---|---|
| 1 | 2 | 3 |
| 4 | 5 | 6 |

Press Up / Down / Left / Right to choose filter parameters and press "OK" to save. Choose the appropriate filter number according to the practical use of the situation, when the number is small it will take longer time to get a data and it will fluctuate more, when the number is large it will take less time to get data and there is less fluctuation, but there is a greater margin of error.

Zero point tracking

Press Up / Down / Left / Right to choose the parameters and press "OK" to save it. When the weight current is equal to or less than the minimum division, "0" appears on the instrument.

Zero Tracking Choose:

| | | |
|---|--------------------------------|--------------------------------|
| <input checked="" type="checkbox"/> +/-1d | <input type="checkbox"/> +/-2d | <input type="checkbox"/> +/-3d |
| <input type="checkbox"/> +/-4d | <input type="checkbox"/> +/-5d | <input type="checkbox"/> +/-6d |

USB/COM

USB/COM Setting:

| |
|--|
| <input checked="" type="checkbox"/> 1 - Cable output setting |
| <input type="checkbox"/> 2 - Wireless output setting |

Press Up / Down to choose USB / RS232 or wireless output configuration,

Cable Output Setting:

| | | | |
|--|-------------------------------|-------------------------------|-------------------------------|
| <input checked="" type="checkbox"/> 1200 | <input type="checkbox"/> 2400 | <input type="checkbox"/> 4800 | <input type="checkbox"/> 9600 |
|--|-------------------------------|-------------------------------|-------------------------------|

Output Data Format:

| |
|--|
| <input checked="" type="checkbox"/> 1 - Cable output setting |
| <input type="checkbox"/> 2 - Wireless output setting |
| <input type="checkbox"/> 2 - Wireless output setting |

Choose the transmission speed and the output format;

Output format:

1- TOLEDO

STX A B C X6 X5 X4 X3 X2 X1 N6 N5 N4 N3 N2 N1 CR

X6 X5 X4 X3 X2 X1 The displayed data, X1 is low, X6 is high;

N6 N5 N4 N3 N2 N1 The tare data, N1 is low, N6 is high;

A B C Bit status

A = 1 1 0 0 0 d2 d1 d0

d2-d0 = 0 without the decimal point

= 1 0.1

= 2 0.01

= 3 0.001

B = 0 0 1 1 0 0 Negative value 0

C = unit

2- XK3190 (D2 + format)

Communication protocol (9 digits ASCII):

= D7 D6 D5 D4 D3 D2 D1 -

Note: D1 ~ D7: The decimal point is included in the numbers, enter "-" in the last digit if it is a negative value, in other cases enter 0.

3- Command

(Reservation function)

Other Settings

Other Setting:

| | |
|----------------------------------|-----|
| 1 - Intelligent Backlight | [E] |
| 2 - Automatic Shutdown | [] |
| 3 - Save Print | [] |

Press the Up / Down buttons to choose the parameters to be configured, [ON] Effective, [OFF] Invalid

1- Intelligent backlight control

The instrument's backlight will turn off after 10 seconds with no operation or stable weight.

2- Automatic shutdown function

The instrument will turn off when it is left without operation for 30 minutes.

3- Save and print

In the main interface, press the button "Save" when the weight is stable, the system will save the data corresponding and will automatically put them to print.

Calibration

Enter the initial password ("123456") to activate the calibration function.

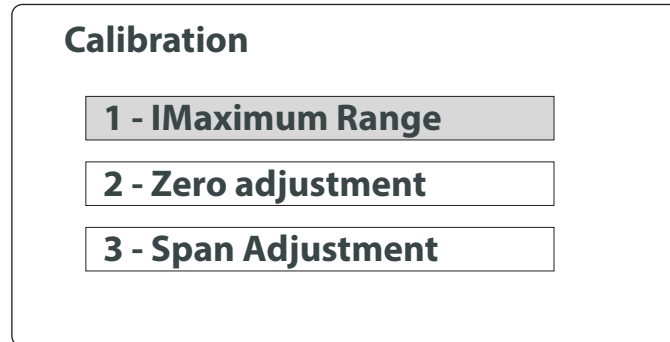

1. Setting the nominal range

Press [OK] to enter, it will appear "1-rated range = 010000 kg" on the interface. Enter the maximum range, press [OK] to save it.

When the weight is greater than the maximum value, the alarm will be activated automatically.

2. Zero point calibration

Press [OK] to start the test without weight, press [OK] to mark the zero point. In calibration process do not put any pressure on the sensor or platform.

3. Full range calibration

Press [OK] to start the full range calibration, load something or weight of already known weight, enter the current weight and press [OK] when the instrument is set, the system will mark the current value automatically. If no changes are needed, press [OK] again to save and exit.

Note: If the indicator receives the information from multiple wireless transmitters, it will need to calibrate separately. each transmitter

A specific operation is opened with only one transmitter, then calibrate it on the indicator according to the method

above, when done, turn off power to the transmitter, turn on another, and calibrate in the same manner as above.

Wireless Settings

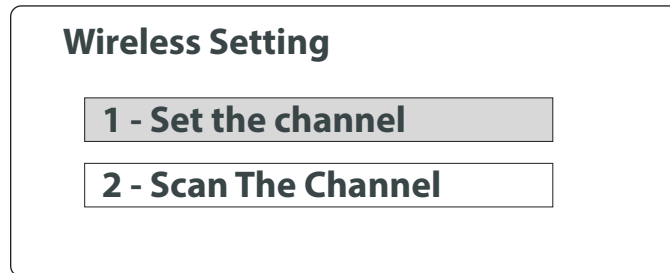

1. Establishment of channels

Enter the new channel numbers and press [OK] to save and exit.

2. Automatic channel search

Press [OK] to start the automatic search of the effective signal from 0 to 99, once found the channel effective immediately.

Attention: Make sure the wireless transmitter is turned on for the first time.

Maintenance

HY680 is a measuring instrument with high precision, good maintenance is very important to increase the reliability and extend the life of the equipment.

The instrument is earthquake resistant and waterproof, but we still need to avoid collision and leave it to the Uncovered in the rain, paying particular attention to preventing it from falling off the hook.

The instrument cannot work in a high temperature environment for long hours, it is necessary to limit the use when there is a source of high temperature in its surroundings. There would be no adverse effects when bottom of instrument is less than 70 degrees.

It is strictly forbidden to carry out welding operations on the instrument to avoid damage to the instrument and the sensor.

Overcharging is strictly prohibited.

Turn off the backlight during the day to conserve battery life.

Installation

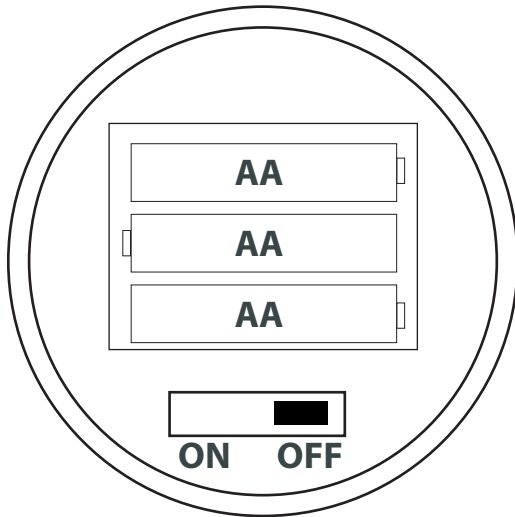

Unscrew the battery cover, install the three (03) required batteries and change the power button to "ON". Install the battery cover.

The dynamometer will start its operation, waiting for the commands of the indicator. The LEDs will not blink until the correct command is read.

When the weight does not change for ten (10) minutes, the dynamometer will enter power saving mode, the LED lights will flash once every three (03) seconds. The dynamometer will exit power save mode automatically when changing applied weight.

Note: It is recommended to leave the power button "OFF" when not in use, and remove the batteries when it is for long periods.



ATTENTION

Make sure to use the correct batteries and verify that they are charged and in good condition.

Configuration

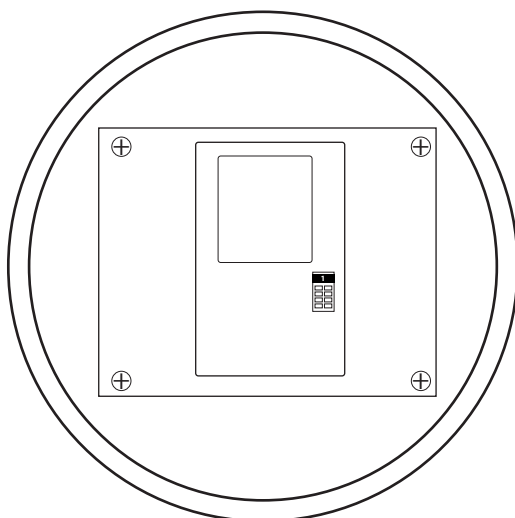

You can adjust between 1 ~ 16 channels with the switch (find out which is the switch), and adjust between 1 ~ 99 channels with the setup software.

The switch is usually used to make the setting.

To make the adjustment with the switch, the cover of the wireless module.

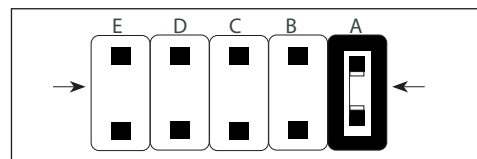

| Interruptor | Parameter | DCBA | Channel | DCBA | Channel | |
|-------------|-------------------|--------------------|---|------|---------|--|
| A | Channel Selection | 0001 | 1 | 0010 | 2 | |
| | | 0011 | 3 | 0100 | 4 | |
| | | 0101 | 5 | 0110 | 6 | |
| B | | 0111 | 7 | 1000 | 8 | |
| | | 1001 | 9 | 1010 | 10 | |
| C | | 1011 | 11 | 1100 | 12 | |
| | | 1101 | 13 | 1110 | 14 | |
| D | | 1111 | 15 | | | |
| E | | Channel Adjustment | 0: Operation Mode 1: Adjustment mood | | | |

Warranty

Limited Warranty Warranty Coverage.

Prowinch guarantees for 3 years from the date of purchase, the operation of this product against any defect in the materials and workmanship used for its manufacture. Our warranty includes repair or change of components at no charge to the customer, including labor.

Prowinch undertakes to deliver the product within a period of no more than 30 days from the date of reception of the same in our service workshops. It will not assume any responsibility in case of delay of the service due to force majeure.

Limitation Of Liability.

1. All guarantees are given in our facilities.
2. In the event a technical site visit is requested, it will always be canceled by the client, regardless of that services are provided at no cost covered by the guarantee. It is understood as a technical field visit to the costs involved for the transfer of personnel, transportation, fuel, food, accommodation, overtime, etc.
3. This warranty does not cover consequential damages, caused by the stoppage of the equipment under review, it does not cover costs transfer of equipment, dismantling, transfer of personnel, loss of earnings, stopped work or any other cost that could be related to the cessation of operation of a team for any reason or motive.
4. To make this guarantee effective, it will be necessary:
 - a) Within the first year, only present the invoice or purchase slip.
 - b) After the first year, proof of annual maintenance in authorized services

Exclusions

This Warranty Will Not Be Valid Under The Following Conditions

1. When the use, care, installation and operation of the product has not been in accordance with the instructions contained in the operation manual and the applied Standards corresponding to each equipment.
2. Lack of preventive maintenance by the user, as stipulated in the Operation Manual and Equipment Maintenance.
3. Lack of annual preventive maintenance at an authorized Prowinch dealer.
4. When the product has been used beyond its capacity, abused, beaten, exposed to humidity, wet by any liquid or corrosive substance, as well as any other fault attributable to the consumer, improper use of the equipment, abuse or neglect.
5. Connection of electrical or electronic components powered by external sources (Normal Network), subject to potential variations.
6. When the product has been disassembled, modified or repaired by persons not authorized by Prowinch.
7. When the failure is caused by the normal wear of the parts due to use.
8. The incorrect use and inappropriate handling of equipment resistant to water or immersion.
9. Damages caused in transport or loading or unloading maneuvers.
10. Occurrence of accidents (Fires, Earthquakes, Floods, Electrical Discharges, etc).
11. Use of non-original spare parts or not recommended by the manufacturer.
12. The warranty does not cover consumable items or other items subject to wear and tear.
13. Commissioning of the equipment by personnel not authorized by Prowinch.
14. Carry out repairs, modifications and / or removal of equipment parts.
15. Installation of winches on bases not properly aligned and without the exact anchor holes.
16. Lack of break-in and oil change in the first 20 hours in equipment with combustion engines.
17. Maintenance costs are not covered by the Warranty.
18. No other verbal or written warranty other than the one expressed here will be recognized by Prowinch

PWHY280

LCD display: 192x64 pixels, 6 status indicators
 Power: 7.4V / 2.2AH Lithium Battery, up to 48h of use per charge
 Ambient Temperature: -10°C ~ 50°C
 % Humidity: ≤85%, at 20°C
 Maximum Distance for Wireless Receiver: 200 m (open areas)
 Radio Frequency: 430 ~ 470MHz

SCREEN SYMBOLS

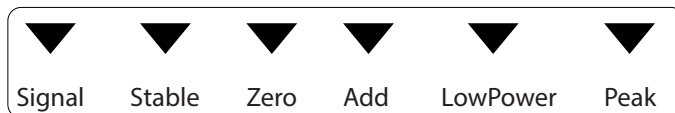

- Signal:** Indicates that the equipment receives the signal correctly.
- Stable:** Indicates that the measured weight data is stable and can be logged.
- Zero:** Indicates status without weight.
- Add:** Indicates that there is data stored in memory, after deleting the data, the symbol will stop appear.
- Low Power:** Indicates that the equipment has low power, the transmitter goes into energy saving mode.
- Peak:** Indicates the maximum value measured.

ADJUST INSTRUCTIONS

| STEPS | OPERATION | SCREEN | NOTE |
|-------|--|----------------------|--|
| 1 | Pulse (OK) | [P 0000] | Enter the function setting, to enter the password |
| 2 | Pulse (OK) Pulse [^] o [v] | [P 9999] | Move the cursor and change the numbers to your password |
| 3 | Pulse [OK] Pulse [^] o [V] Pulse [C] Salir | [FUNC 0] | Select function setting: 1: Working mode 2: Filter Setting (0 ~ 9) 3: Set the sender number 4: Set the frequency (channel) |
| 4 | Pulse [OK] Pulse [^] o [V] Pulse [C] Out | [FUNC 1] [edn 2] | Compatibility Selection: 1: PWHY280 2: PWHY |
| 5 | Pulse [OK] Pulse [^] o [V] Pulse [C] Out | [FUNC 2] [FLT 2] | Adjust the filter (0~3) |
| 6 | Pulse [OK] Pulse [^] o [V] Pulse [C] Out | [FUNC 3] [Rec 01] | Adjust the number of the transmission |
| 7 | Pulse [OK] Pulse [^] o [V] | [FUNC 4] [FRC 01] | Adjust the Frequency. Example: 01 is channel 01 |
| 8 | Pulse [OK] | Out | |

Calibration Instructions

| STEPS | OPERATION | SCREEN | NOTE |
|-------|---|-----------------------|---|
| 1 | Pulse (OK) | [P 0000] | Enter the function setting, to enter the password |
| 2 | Pulse (OK) Pulse [^] o [v] | [P 8888] | Move the cursor and change the numbers to your password |
| 3 | Pulse [>>] Pulse [OK] | [E 001] [E 005] | Set the desired precision: 1, 2, 5, 10, 20, 50, 100 For example: 5 kg |
| 4 | Pulse [>>] Pulse [OK] | [DC 0] [DC 0] | Number of decimals: 0, 1, 2, 3 For example: 0 |
| 5 | Pulse [>>] Pulse [OK] | [unit kg] [unit T] | Select unit of measure: kg, T, lb, kN For example: T |
| 6 | Pulse [>>] Pulse [^] o [V] Pulse [OK] | [010000] | Set the maximum value, if this value is exceeded, the system alarm will go off For example: 10000kg |
| 7 | Pulse [OK] | [noload] | Indicates no-load calibration (press [C] to skip this operation) |
| 8 | Pulse [OK] | [adload] | Select the load calibration |
| 9 | Pulse [>>] Pulse [^] o [V] Pulse [OK] | [030000] | Move the cursor, changing the values of the standard calibration (press [C] to skip this operation) |
| 10 | Pulse [OK] | [012345] | Show the type of object, at the moment, it can also be subject to changes, increase or decrease show weight |
| 11 | | RETURN | Calibration completed |

Storage function

| STEPS | OPERATION | SCREEN | NOTE |
|-------|------------|--------|--|
| 1 | Pulse (OK) | | In weight-bearing condition, pressing this button can automatically save the information of memory. |

Search function

| STEPS | OPERATION | SCREEN | NOTE |
|-------|-------------------------------|----------|---|
| 1 | Pulse | [no 020] | In weight load condition, pressing this button will it will show the information according to the last registered charge. |
| 2 | Pulse [>>] Pulse [^] o [V] | | Displays the recorded data of the last uploads, use the cursors to navigate. |
| 3 | Pulse [C] | | Out |

Addition Function

| STEPS | OPERATION | SCREEN | NOTE |
|-------|-----------|--------|--|
| 1 | Pulse | [0] | In weight load condition, press this button to addition the data from different measurements and obtain a total value. |
| 2 | Pulse [C] | | Delete the reorded addition to returns to the normal measurement condition. |

Deleted Function

| STEPS | OPERATION | SCREEN | NOTE |
|-------|--------------------------|---------|---|
| 1 | Pulse | [CLR 0] | |
| 2 | Pulse [>>] Pulse [OK] | [CLR *] | 1. Erase the last register data. 2. Deleted all register data. |
| 3 | | [END] | End up the erase function |

Maximum value display

| STEPS | OPERATION | SCREEN | NOTE |
|-------|-----------|---------|---|
| 1 | Pulse | [*****] | It will display the maximum value loaded (PEAK) and the peak indicator will be displayed. After of 1 second it will return to normal condition. |

Backlight Function

| STEPS | OPERATION | SCREEN | NOTE |
|-------|-----------|---------|---|
| 1 | Pulse | [*****] | When the screen show backlight, press the botton to turn off. |

Adjust time function

| STEPS | OPERATION | SCREEN | NOTE |
|-------|--|------------|---|
| 1 | Pulse | [11-01-01] | Show the current date in the system |
| 2 | Pulse [>>] or Pulse [^] o [v] Pulse [OK] | | Move the cursor and set the current date, Pulse [OK] to save |
| 3 | Pulse | [12-08-02] | Show the current date. |
| 4 | Pulse [>>] or Pulse [^] o [v] Pulse [OK] | | Move the cursor, and set the current date. Pulse [OK] to save. |

ERR 05

The equipment is not receiving the correct weight signal, please check the battery and the antenna.

--OV--

The Equipment shows over condition load. Check if the load is inside of the range of the dynamometer used. If the load meets the parameters of your dynamometer it is possible that the transmitter is damaged and needs to be repaired.

Technical Parameters

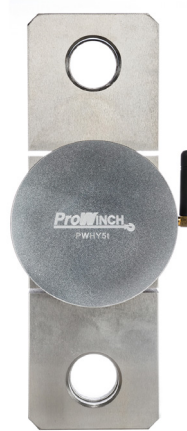

| CODE | PWHY5T | PWHY10T | PWHY25T | PWHY50T | PWHY100T |
|--------------------------------------|-----------------------------|-----------------------------|-----------------------------|-----------------------------|-----------------------------|
| Accuracy Grade | Grade III | Grade III | Grade III | Grade III | Grade III |
| Rated Capacity | 11000 Lb | 22000 Lb | 55000 Lb | 110000 Lb | 220000 Lb |
| Sensitivity | (2.0 ± 0.1%) m V/V | (2.0 ± 0.1%) m V/V | (2.0 ± 0.1%) m V/V | (2.0 ± 0.1%) m V/V | (2.0 ± 0.1%) m V/V |
| Wireless Frequency / Distance | 430 to 470MHz/1000Ft | 430 to 470MHz/1000Ft | 430 to 470MHz/1000Ft | 430 to 470MHz/1000Ft | 430 to 470MHz/1000Ft |
| Power Supply | Battery7.4v/8.4v Charger | Battery7.4v/8.4v Charger | Battery7.4v/8.4v Charger | Battery7.4v/8.4v Charger | Battery7.4v/8.4v Charger |
| A/D Conversion Rate | 50Times /Second | 50Times /Second | 50Times /Second | 50Times /Second | 50Times /Second |
| Scale Interval | 1/2/5/10/20/50 Lb | 1/2/5/10/20/50 Lb | 1/2/5/10/20/50 Lb | 1/2/5/10/20/50 Lb | 1/2/5/10/20/50 Lb |
| Operating Temperature | -30° - 20° C | -30° - 20° C | -30° - 20° C | -30° - 20° C | -30° - 20° C |
| Weight | 13 Lbs | 21.5 Lbs | 44 Lbs | 68,3 Lbs | 196 Lbs |

Dimensions

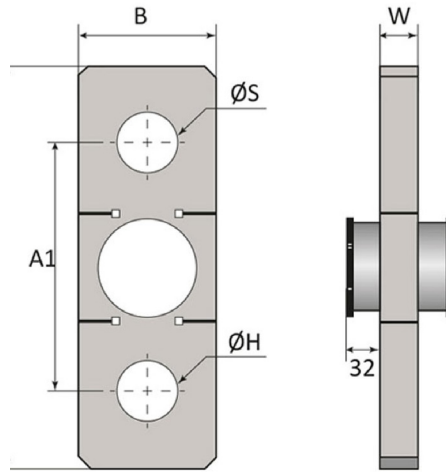

| CODE | PWHY5T | PWHY10T | PWHY25T | PWHY50T | PWHY100T |
|-----------|---------------|---------|---------|---------|----------|
| A | 9.0 in/ 230mm | 11.0 in | 14.6 in | 16.9 in | 22.4 in |
| A1 | 6.3 in | 7.4 in | 9.0 in | 10.2 in | 5.4 in |
| B | 3.0 in | 3.5 in | 0.9 in | 5.9 in | 8.3 in |
| W | 1.3 in | 1.8 in | 2.2 in | 2.6 in | 4.3 in |
| ØS | 1.1 in | 1.6 in | 2.1 in | 2.9 in | 4.0 in |
| ØH | 0.8 in | 1.1 in | 2.1 in | 2.9 in | 4.0 in |

Optionals



PWHY280

Simple remote control with display



PWHY680

Remote control with display and printer

PWHYCS

Accuracy: Grade III, n = 3000

Sampling Rate: 80 times / second

Interval scale: 1/2/5/10/20/50 per option

Display: 6-bit LCD, 6-stage light indication

Communication interface: wireless signal

Power Source: AA 1.5Vx3 batteries

Operation Temperature / Humidity: -10 ~ 45 ° C; 90% RH

Transport Temperature: -20 ~ 50

Installation

- Principal functions
- [FUNC] Hold down the button for 5 more seconds at the time of weighing, it will enter the setting mode.
- operation.
- [>] Press this button to turn the backlight on / off.
- [^ / ZERO] Press this button to enter zero weight.
- [ON] Press this button to start the indicator when it is off; and press it to turn it off when switched on.

Calibration

Turn on the indicator, press [FUNC] while it is starting up, it will enter the calibration mode and calibrate as follows

| STEPS | OPERATION | SCREEN | NOTE |
|-------|--|----------|--|
| 1 | Pulse [^] to select division | [d X] | Division selection options (12/5/10/20/50), press [FUNC] to confirm Example: 20 |
| 2 | Pulse [^] to select the decimal point | [P X] | Decimal point selection options 0 ~ 3. Press [FUNC] to confirm Example: 3 |
| 3 | Set the range completely | [FULL] | Press [^] to select the digit bit; Press [>] to select the other digit; Press [FUNC] to confirm the full range input |
| 4 | Zero point calibration: Press [FUNC] when the stable signal | [nOLOAD] | Make sure there is no load |
| 5 | Calibration of the complete range point | [AdLOAD] | While entering the loaded weight, Press [^] for digit selection bit; Press [>] to select the digit, when the entered values are equal to the loaded weight and the digit bit is the maximum bit, press [FUNC] when the signal stabilizes |

| | |
|---|--|
| 6 | [End] |
| 7 | One second after the instrument stores the parameters automatically, it will return to weighing. (Optional instrument with touch calibration switch, the meter will store the parameters and will return to weigh-in) |

OPERATION

Switch On And Automatic Zero Configuration

- The indicator will display “999996-000000” when turn on to auto verification. Then will be in weight mood.
- When turned on, if the weight loaded on the scale deviates from zero point but is still within zero range, the indicator will set zero automatically; If it is out of range, you need to adjust zero point, recalibrate or reset.

Set up manually the Zero (Automatically)

- In the weight mood, when show up any mistake being charge, press [^] to make the indicator to be Zero.
- If the values go down from Zeor point, but they’re still on zero point. press the available option [^]. Anyway [^]the key is invalidate (In this case recalibrate or reset parameters Zero)

Tare Function

When the weighting status indicator showing a stable positive weight, press the [Tare] button, the indicator will deduct the displayed weight as the package weight. Then the indicator will show the net weight as “0” and will turn on the tare function announcement signal.

Ussers Function Configurations

In weighing mode, keep pressing [FUNC] for more than 5 seconds, it will enter the setting mode (P mode), there are 12 modes from P1 to p12 for options, press [>] to select the mode and press [^] to select the parameter. The description of the parameters is as follows:

| USSER FUNCTION CONFIGURATIONS | | |
|-------------------------------|--|--|
| 1P1 | X | Switch Kg - Lb |
| | x=1: x=2: | Show up Kg Show up Lb |
| 2P2 | X | Turn off automatically |
| | X=1 X=2 X=3 X=4 | Do not use this function Turn of after 10 min 20 min 30 min |
| 3P3 | X | Transmission Range Setting |
| | X=1:9600 (If the connection is through wireless indicator you should slect this option) x=2 4800 | |

| | | |
|--------------|---|--|
| 4P4 | X=3 X=4 X X=1 X=2 | 2400 1200 RS232 Weight option of out net/gross Net / Weight output Net / Weight output |
| 5P5 | X X=1: X=2: X=3: X=4: | RS232 Output option mood Without transmission (Stop RS232) Transmission continuous 1 Continuous transmission when stabilized Command mode (Z: zero, T: Tare, R: transmit weight data once) |
| | X=5: X=6: X=7: X=8: | Current loop output (optional) Hold (Print) Continuous transmission 2 X Continuous transmission 3 |
| 6P6 | X X=addr: | Communication direction of configuration Addr=Options from 1 - 9 |
| 7P7 | X X=1: X=2: X=3: X=4: X=5: X=6: X=7: | 0.5e 1.0e 1.5e 2.0e 2.5e 3.0e 5.0e |
| 8 P8 | X X=1: X=2: X=3: X=4: X=5: | Zero button range 2% FS 4% FS 10% FS 20% FS 100% FS |
| 9P9 | X X=1: X=2: X=3: X=4: X=5: | Zero button range 2% FS 4% FS 10% FS 20% FS 100% FS |
| 10P10 | X X=1: X=2: X=3: | Digital intense filter Tall Average Down |
| 11P11 | X X=1: X=2: X=3: | Stabilization time Tall Average Down |
| 12p12 | X X=1 X=2 X=3 | Measurement Stability Tall Average Down |

Error Indication

| | |
|---------------|--|
| ERR 1 | Values is too small when is calibrated |
| EER 2 | Point zero is out of the range when is calibrated |
| EER 3 | Point zero is out of range when turn on |
| EER 4 | The sample number entered is zero when sampling in counting mode |
| EER5 | The entered weight is zero when full scale is calibrated in calibration mode |
| EER6 | The unit of weight is zero when |
| bAT-IO | Low battery |
| --OV-- | Overload warning |

Technical Parameters



| CODE | PWHYCS1T | PWHYCS5T | PWHYCS10T | PWHYCS20T | PWHYCS30T | PWHYCS50T |
|---|--------------------|--------------------|--------------------|--------------------|--------------------|--------------------|
| Accuracy Grade | Grade III | Grade III | Grade III | Grade III | Grade III | Grade III |
| Rated Capacity | 11000 Lb | 22000 Lb | 55000 Lb | 110000 Lb | 220000 Lb | 110200Lb |
| Minimum Weight | 22 Lb | 88 Lb | 220 Lb | 440 Lb | 440 Lb | 880 Lb |
| Power Supply | 3 Battery AA 1.5VV | 3 Battery AA 1.5VV | 3 Battery AA 1.5VV | 3 Battery AA 1.5VV | 3 Battery AA 1.5VV | 3 Battery AA 1.5VV |
| Sample Rate | 80Times /Second | 80Times /Second | 80Times /Second | 80Times /Second | 80Times /Second | 80Times /Second |
| Scale Interval | 1/2/5/10/20/50 Lb | 1/2/5/10/20/50 Lb | 1/2/5/10/20/50 Lb | 1/2/5/10/20/50 Lb | 1/2/5/10/20/50 Lb | 1/2/5/10/20/50 Lb |
| Operating Temperature / Humidity | -10° 45° C/s 90%H | -10° 45° C/s 90%H | -10° 45° C/s 90%H | -10° 45° C/s 90%H | -10° 45° C/s 90%H | -10° 45° C/s 90%H |
| Transporting Temperature | -20° - 50° C | --20° - 50° C | -20° - 50° C | -20° - 50° C | -20° - 50° C | -20° - 50° C |
| Total Weight | 3.5 Lbs | 5.9 Lbs | 22.9 Lbs | 39.2 Lbs | 55.1 Lbs | 85.9 Lb |

Dimensions

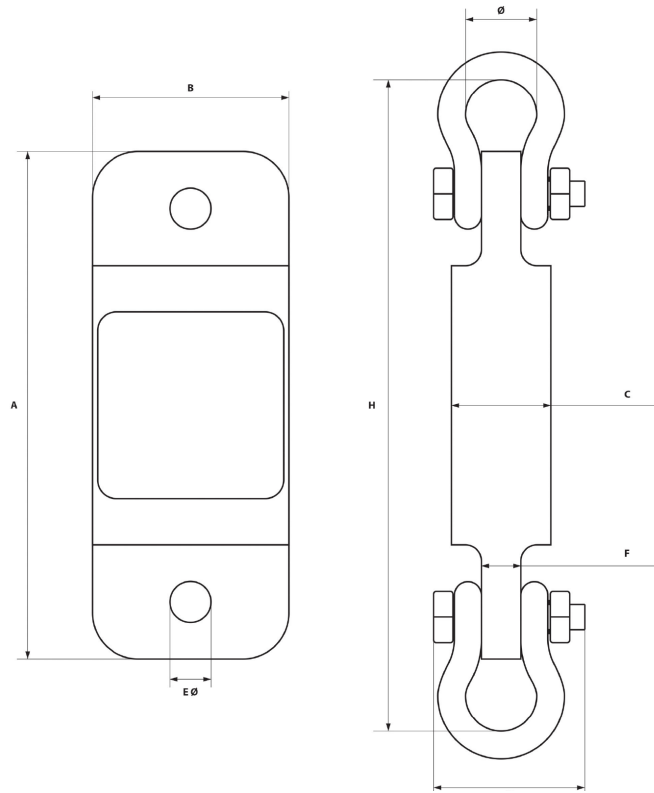

| CODE | PWHYCS1T | PWHYCS5T | PWHYCS10T | PWHYCS20T | PWHYCS030T | PWHYCS50T |
|-----------|-----------------------|---------------------|---------------------|-------------------|-------------------|-------------------|
| A | 9 5/8 in 244.5 mm | 11 1/4 in 286 mm | 12 1/3 in 318 mm | 16.5 in 420 mm | 16.5 in 420 mm | 18.3 in 465 mm |
| B | 3 3/4 in 95.3 mm | 4 in 102 mm | 4 1/2 in 114 mm | 4.8 in 128 mm | 5.4 in 138 mm | 5.9 in 150 mm |
| C | 1 7/8 in 47.6 mm | 2 in 51 mm | 1 7/8 in 48 mm | 2.8 in 70 mm | 3.1 in 80 mm | 3.9 in 100 mm |
| D | 2 13/16 in 71.4 mm | 4 7/8 in 124 mm | 6 1/2 in 165 mm | 10.2 in 260 mm | 11 in 280 mm | 12 in 305mm |
| Ø | 1 3/8 in 34.9 mm | 2 1/4 in 57 mm | 3 1/4 in 83 mm | 5 in 127 mm | 5.7 in 146 mm | 7.2 in 184 mm |
| H | 12 in 304.8 mm | 16 in 406 mm | 19 1/2 in 495 mm | 25.9 in 660 mm | 29.1 in 740 mm | 36.6 in 930 mm |
| EØ | 13/16 in 19.6 mm | 1 7/6 in 37 mm | 1 7/6 in 37 mm | | | |
| F | 3/4 in 19.04 mm | 1 3/8 in 35 mm | 1 7/8 in 48 mm | | | |

Optionals



PWHY280

Simple remote control with display



PWHY680

Remote control with display and printer

Software and wireless interface for dynamometers of PWHYCS and PWHYCS Series.



Direct connection with PWHYCS Series
Connection with PWHY series requires a PWHY280/680 Unit

Crane scale Prowinch website Interface

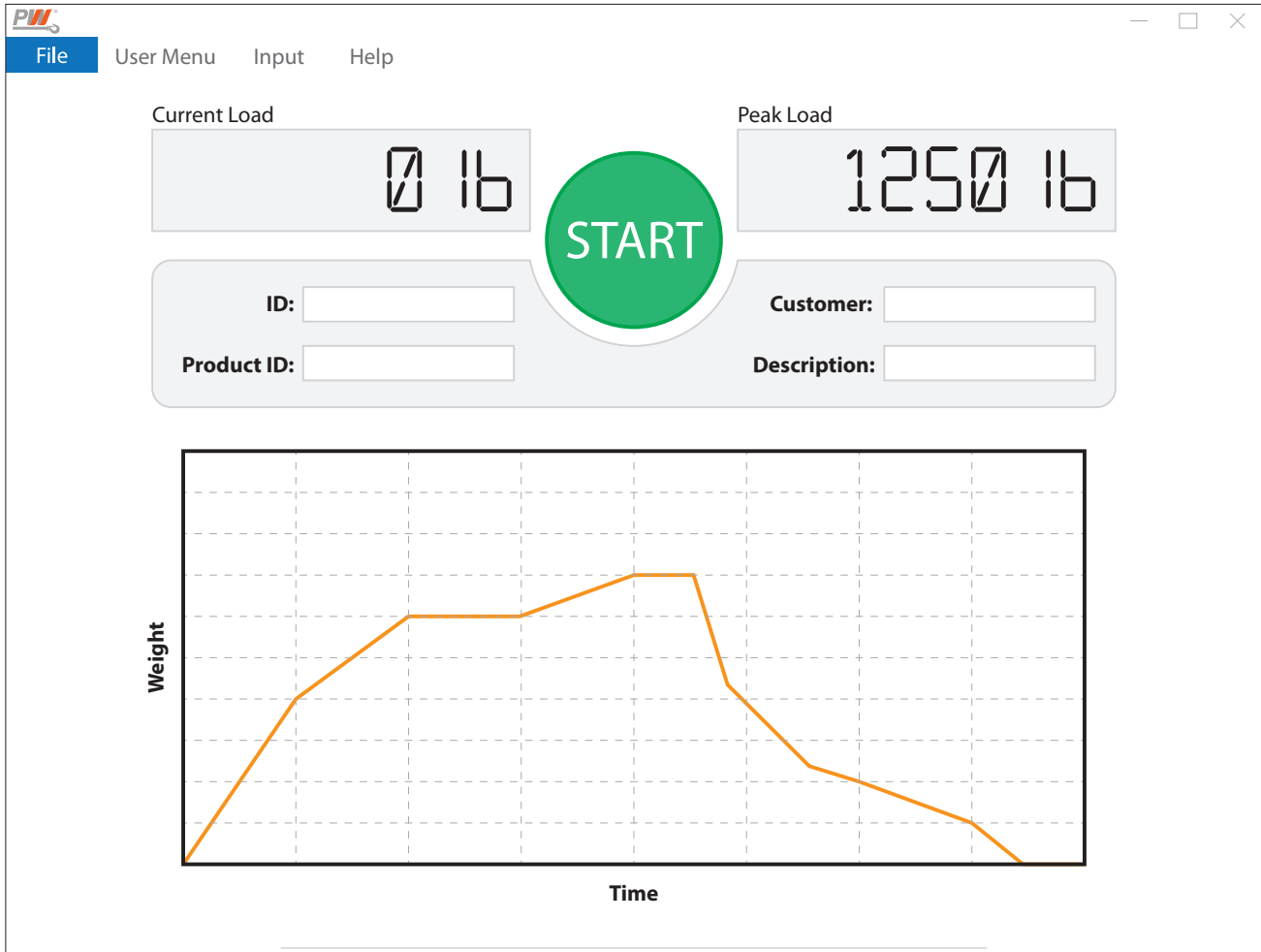

Accessories

PWHYD



3, 5, 8, In front Display for PWHY series Crane Scales

PWHYA



3 Antenna 650 Ft for PWHY Crane Scale series

PWHYA300



3Antenna 1000 Ft for PWHY Crane Scale series

Index

| | |
|--|-----------|
| PROWINCH® DISCLAIMER..... | 4 |
| SAFETY PRECAUTIONS..... | 6 |
| Applications For PWHY Dynamometer..... | 6 |
| Mandatory Use Of..... | 7 |
| General Precautions..... | 8 |
| General Enviromental Precautions..... | 10 |
| SPECIFICATIONS..... | 11 |
| Technical Parameters..... | 11 |
| Interruptor..... | 12 |
| Main Interface..... | 13 |
| Function Configuration..... | 13 |
| Other settings..... | 18 |
| Installation..... | 21 |
| Configuration..... | 21 |
| Warranty..... | 22 |
| PWHY..... | 24 |
| Technical parameters..... | 24-29 |
| PWHYCS..... | 30 |
| Technical parameters..... | 30-37 |



PROWINCH LLC
www.prowinch.com

2545 NW 74th Ave
Miami, FL 33122
United States
+1 (800) 971-8061

EQUIPOS DE IZAJE PROWINCH CHILE SPA
www.prowinch.cl

Parque Riesco 3407, Recoleta,
Región Metropolitana, Chile
+56-2-26218989

FORTIS ALLOY MEXICO S.A. DE C.V.
www.prowinch.mx

Fortis Alloy Mexico, S.A. de C.V. Vicente
Guerrero No. 403
Col. San Miguel, Apodaca, Nuevo Leon,
Mexico C.P. 66649
+52 (81) 8244-1351

PROWINCH COLOMBIA SAS
www.prowinch.co

Cl. 163a #20-28,
Bogotá Colombia
(+57) 1 7034035

**PROVEEDORA INDUSTRIAL Y TECNICA,
S.A. DE C.V.**
www.prointe.com.sv

Av. Alberto Masferrer Sur, Col.
Campestre No. 211
San Salvador, El Salvador
2264-1100

REPRESENTACIONES IVANKOVICH RA S.A.
ivankovich.co.cr

100 mt. Este y 300 Mt. Sur de las Oficinas
Centrales del INS,
Cartago, Costa Rica
(506) 2553-1415